

SPECIFICATION

IMAGE FORMAT	1/2"
FOCAL LENGTH	22mm
H.F.O.V.	15°
RESOLUTION	2MP
APERTURE	F1.6
MOUNT	M12X0.5
IRIS	Fixed
FOCUS	Manual
ZOOM	Fixed
M.O.D.	0.2m

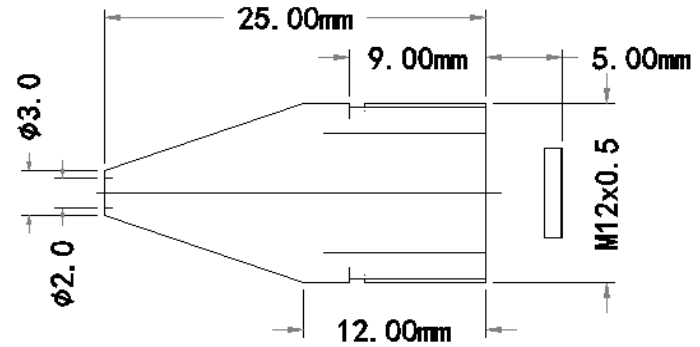

SCALE		DRAWN		MODEL	CCL1222PMP	REV	DESCRIPTION	DATE	NAME
DATE		CHECK		 香港致远电子集团有限公司 HONGKONG TOWIN ELECTRONICS CO.,LTD.		①			
UNIT	mm	APPROVE				②			
						③			