

SPECIFICATION

IMAGE FORMAT	1/2.5"
FOCAL LENGTH	3.6mm
F.O.V.(IMX322)	124°
	103°
	57°
RESOLUTION	3 MP
TV DISTORTION	<-25%
APERTURE	F1.8
MOUNT	M12x0.5
IRIS	Fixed
M.O.D.	0.1m
T.T.L.	22.2mm
STRUCTURE	5G

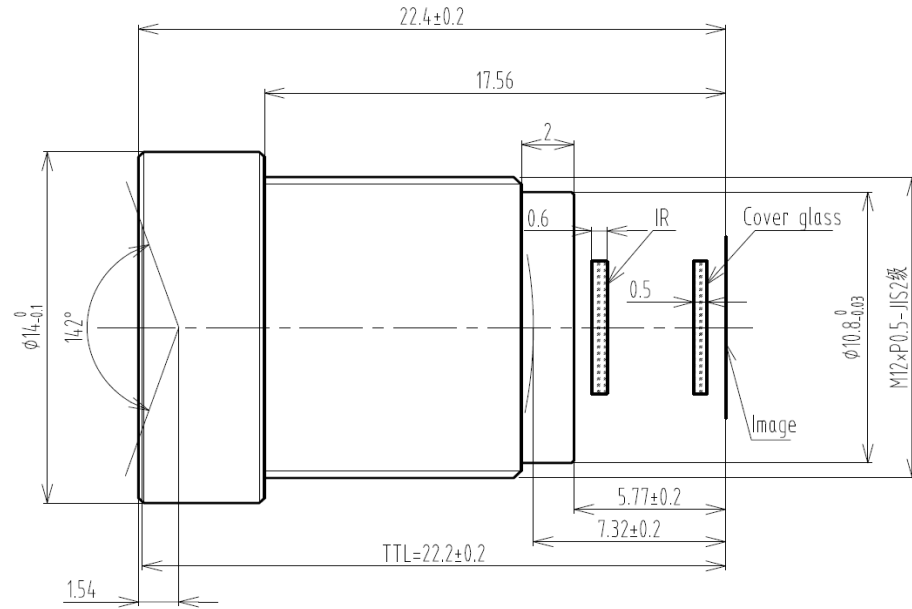

SCALE		DRAWN		MODEL	S03612510318	REV	DESCRIPTION	DATE	NAME
DATE		CHECK		 香港致远电子集团有限公司 HONGKONG TOWIN ELECTRONICS CO.,LTD.		①			
UNIT	mm	APPROVE				②			
						③			